

**General Descriptions**

- DDC144NS features discrete dual NPN transistors that can support continuous maximum current up to 100 mA. It is suited for applications where the load needs to be turned on and off using circuits like micro-controllers, comparators, etc., particularly at a point of load. The component devices can be used as a part of a circuit or as a stand alone discrete device.

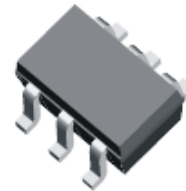

Fig. 1: SOT-363

**Features**

- Epitaxial Planar Die Construction
- Ideally Suited for Automated Assembly Processes
- **Lead Free By Design/RoHS Compliant (Note 1)**
- **"Green" Device (Note 2)**

**Mechanical Data**

- Case: SOT-363
- Case Material: Molded Plastic. "Green" Molding Compound. UL Flammability Classification Rating 94V-0
- Moisture Sensitivity: Level 1 per J-STD-020C
- Terminal Connections: See Figure 2
- Terminals: Finish - Matte Tin annealed over Alloy 42 leadframe. Solderable per MIL-STD-202, Method 208
- Marking Information: See Page 3
- Ordering Information: See Page 3
- Weight: 0.0065 grams (approximate)

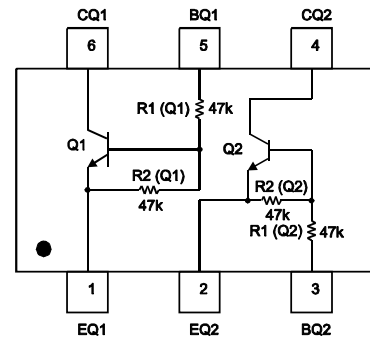

Fig. 2: Schematic and Pin Configuration

**Maximum Ratings, Total Device**

@T<sub>A</sub> = 25°C unless otherwise specified

| Characteristic                                       | Symbol                            | Value       | Unit |
|--|-----------------------------------|-------------|------|
| Power Dissipation (Note 3)                           | P <sub>d</sub>                    | 200         | mW   |
| Thermal Resistance, Junction to Ambient Air (Note 3) | R <sub>θJA</sub>                  | 625         | °C/W |
| Operating and Storage Temperature Range              | T <sub>j</sub> , T <sub>STG</sub> | -55 to +150 | °C   |
| Collector Current                                    | I <sub>C(max)</sub>               | 100         | mA   |

**Maximum Ratings:**

**Sub-Component Device - Pre-Biased NPN Transistor**

@T<sub>A</sub> = 25°C unless otherwise specified

| Characteristic | Symbol          | Value      | Unit |
|----------------|-----------------|------------|------|
| Supply Voltage | V <sub>CC</sub> | 50         | V    |
| Input Voltage  | V <sub>in</sub> | -10 to +40 | V    |
| Output Current | I <sub>O</sub>  | 100        | mA   |

**Electrical Characteristics:**

**Pre-Biased NPN Transistor**

@T<sub>A</sub> = 25°C unless otherwise specified

| Characteristic                | Symbol              | Min | Typ | Max  | Unit | Test Condition   |
|-------------------------------|---------------------|-----|-----|------|------|--|
| Input Voltage                 | V <sub>I(off)</sub> | 0.5 | 1.1 | —    | V    | V <sub>CC</sub> = 5V, I <sub>O</sub> = 100uA             |
|                               | V <sub>I(on)</sub>  | —   | 1.5 | 3    | V    | V <sub>O</sub> = 0.3V, I <sub>O</sub> = 2mA              |
| Output Voltage                | V <sub>O(on)</sub>  | —   | 0.1 | 0.3  | V    | I <sub>O</sub> /I <sub>I</sub> = 10mA/0.5mA              |
| Input Current                 | I <sub>I</sub>      | —   | —   | 0.18 | mA   | V <sub>I</sub> = 5V                                      |
| Output Current                | I <sub>O(off)</sub> | —   | —   | 0.5  | uA   | V <sub>CC</sub> = 50V, V <sub>I</sub> = 0V               |
| DC Current Gain               | G <sub>I</sub>      | 100 | —   | —    | —    | V <sub>O</sub> = 5V, I <sub>O</sub> = 5mA                |
| Input Resistor (R1) Tolerance | Δ R1                | -30 | —   | +30  | %    | —  |
| Resistance Ratio Tolerance    | R2/R1               | -20 | —   | +20  | %    | —  |
| Gain-Bandwidth Product        | f <sub>T</sub>      | —   | 250 | —    | MHz  | V <sub>CE</sub> = 10V, I <sub>E</sub> = 5mA, f = 100 MHz |

- Notes:
1. No purposefully added lead.
  2. Diodes Inc.'s "Green" policy can be found on our website at [http://www.diodes.com/products/lead\\_free/index.php](http://www.diodes.com/products/lead_free/index.php).
  3. Device mounted on FR-4 PCB, 1 inch x 0.85 inch x 0.062 inch; pad layout as shown on page 4 or go to Diodes Inc. suggested pad layout document AP02001, which can be found on our website at <http://www.diodes.com/datasheets/ap02001.pdf>

## Typical Characteristics of NPN Transistor

@  $T_A = 25^\circ\text{C}$  unless otherwise specified

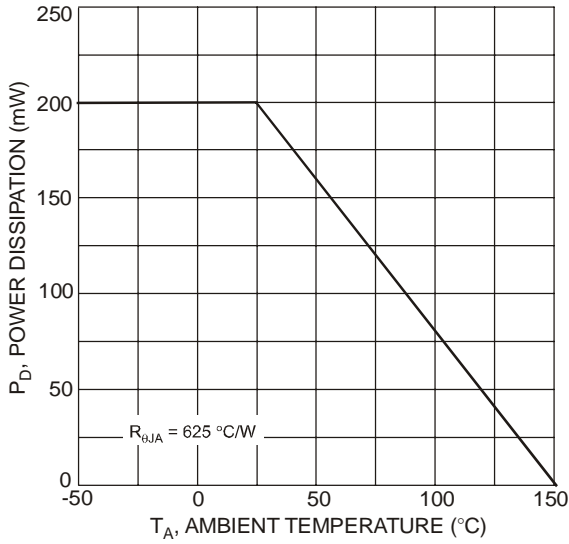

Fig. 3 Derating Curve

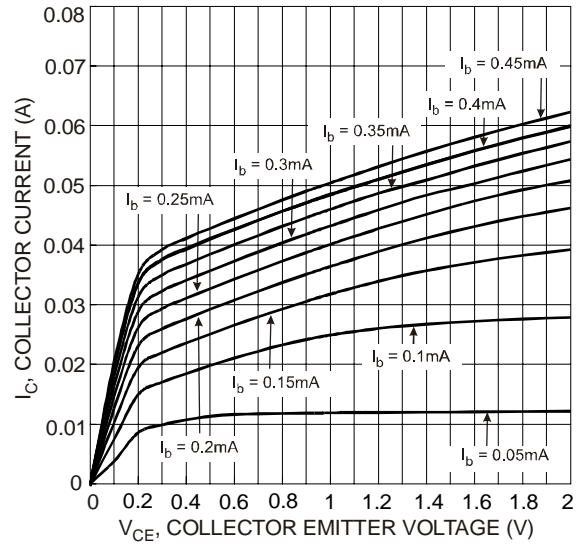

Fig. 4 Typical  $V_{CE}$  vs.  $I_C$

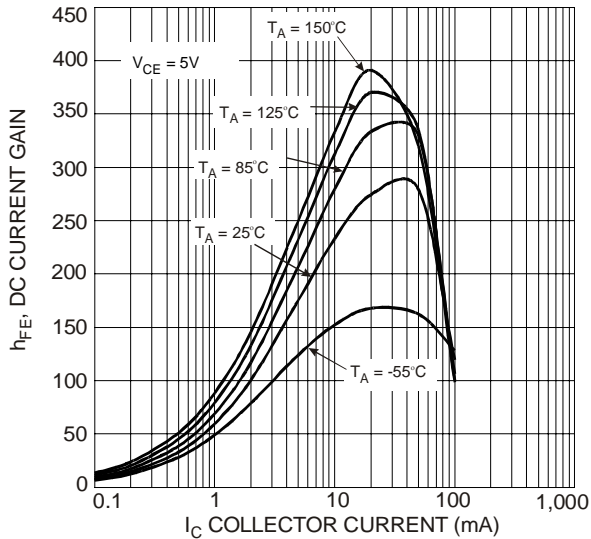

Fig. 5 Typical DC Current Gain

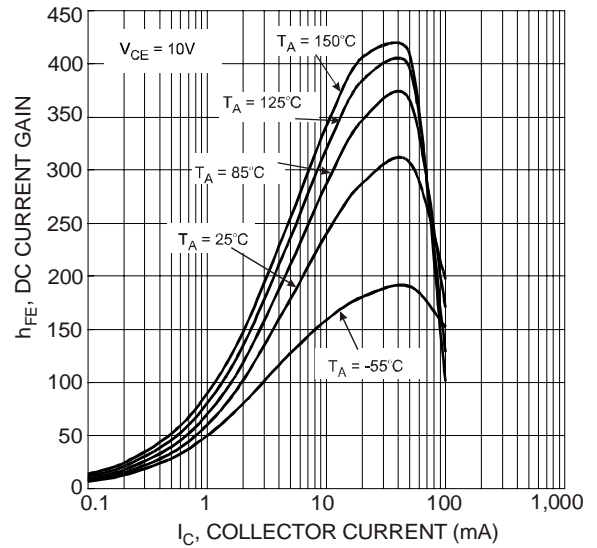

Fig. 6 Typical DC Current Gain

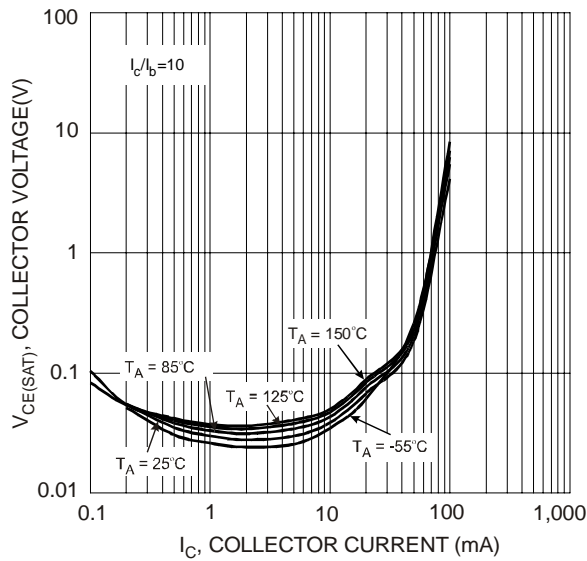

Fig. 7 Typical  $V_{CE(SAT)}$  vs.  $I_C$

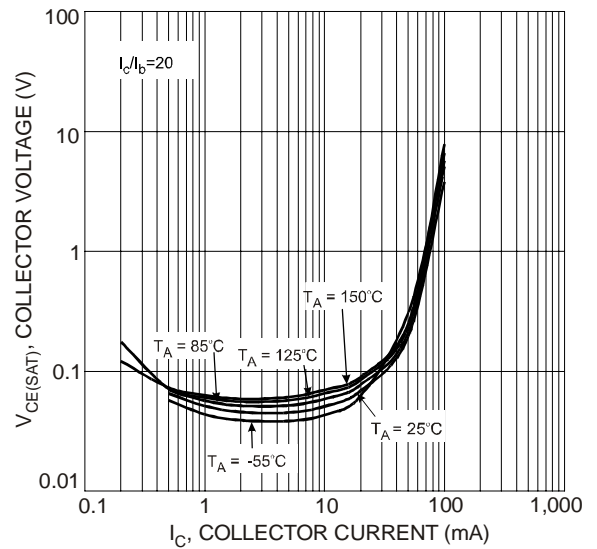

Fig. 8 Typical  $V_{CE(SAT)}$  vs.  $I_C$

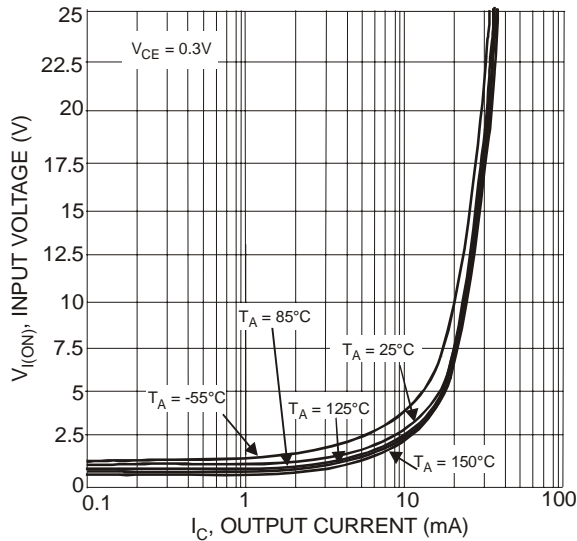

Fig. 9 Typical Input Voltage vs. Output Current

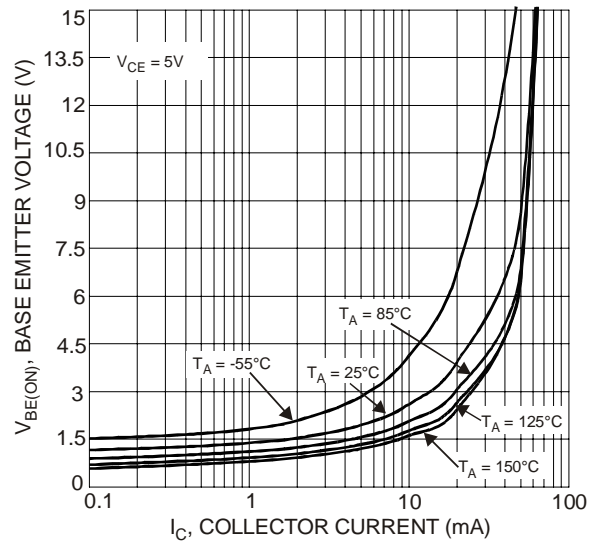

Fig. 10 Typical  $V_{BE(ON)}$  vs.  $I_C$

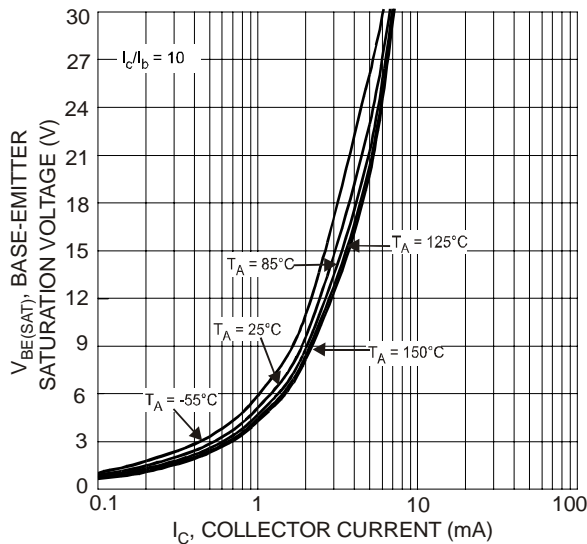

Fig. 11 Typical  $V_{BE(SAT)}$  vs.  $I_C$

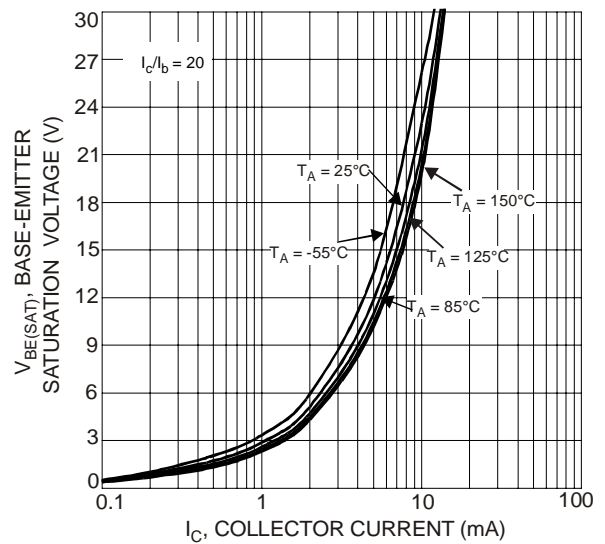

Fig. 12 Typical  $V_{BE(SAT)}$  vs.  $I_C$

## Ordering Information (Note 4)

| Device     | Packaging | Shipping         |
|------------|-----------|------------------|
| DDC144NS-7 | SOT-363   | 3000/Tape & Reel |

Notes: 4. For packaging details, go to our website at <http://www.diodes.com/datasheets/ap02007.pdf>.

## Marking Information

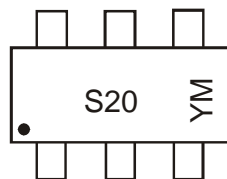

Fig. 13

S20 = Product Type Marking Code,  
 YM = Date Code Marking  
 Y = Year, e.g., T = 2006  
 M = Month, e.g., 9 = September

### Date Code Key

| Year | 2005 | 2006 | 2007 | 2008 | 2009 | 2010 | 2011 | 2012 |
|------|------|------|------|------|------|------|------|------|
| Code | S    | T    | U    | V    | W    | X    | Y    | Z    |

| Month | Jan | Feb | Mar | Apr | May | Jun | Jul | Aug | Sep | Oct | Nov | Dec |
|-------|-----|-----|-----|-----|-----|-----|-----|-----|-----|-----|-----|-----|
| Code  | 1   | 2   | 3   | 4   | 5   | 6   | 7   | 8   | 9   | O   | N   | D   |

**Package Outline Dimensions**

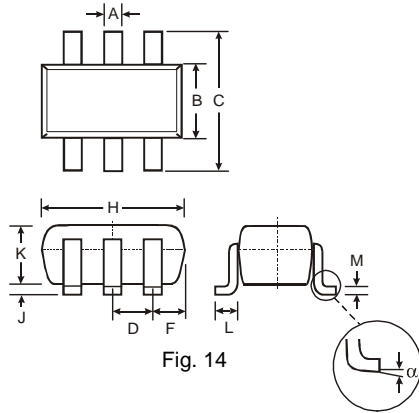

| SOT-363              |              |      |
|----------------------|--------------|------|
| Dim                  | Min          | Max  |
| A                    | 0.10         | 0.30 |
| B                    | 1.15         | 1.35 |
| C                    | 2.00         | 2.20 |
| D                    | 0.65 Nominal |      |
| F                    | 0.30         | 0.40 |
| H                    | 1.80         | 2.20 |
| J                    | —            | 0.10 |
| K                    | 0.90         | 1.00 |
| L                    | 0.25         | 0.40 |
| M                    | 0.10         | 0.25 |
| $\alpha$             | 0°           | 8°   |
| All Dimensions in mm |              |      |

**Suggested Pad Layout**

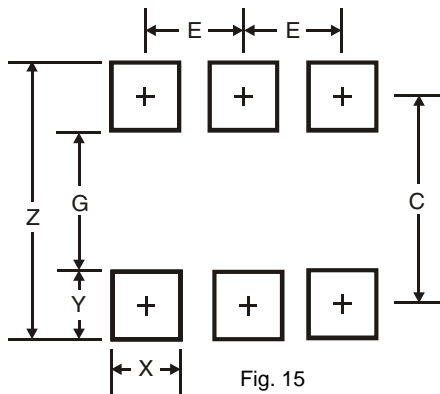

| Dimensions | SOT-363* |
|------------|----------|
| Z          | 2.5      |
| G          | 1.3      |
| X          | 0.42     |
| Y          | 0.6      |
| C          | 1.9      |
| E          | 0.65     |

\* Typical dimensions in mm

**IMPORTANT NOTICE**

Diodes Incorporated and its subsidiaries reserve the right to make modifications, enhancements, improvements, corrections or other changes without further notice to any product herein. Diodes Incorporated does not assume any liability arising out of the application or use of any product described herein; neither does it convey any license under its patent rights, nor the rights of others. The user of products in such applications shall assume all risks of such use and will agree to hold Diodes Incorporated and all the companies whose products are represented on our website, harmless against all damages.

**LIFE SUPPORT**

Diodes Incorporated products are not authorized for use as critical components in life support devices or systems without the expressed written approval of the President of Diodes Incorporated.